

Canal impeller - free passage 80mm



BZ 3-phase
50Hz

Specifications:

Model		Colour code curve	Bore mm	Power output kW	Phases	r.p.m.	Head max. m	Capacity max. l/min	Starting method	Dry weight kg without cable		Impeller passage mm
free standing	with guide rail fitting									free standing	with guide rail fitting	
100BZ45.5	TOS100BZ45.5	● 1	100	5,5	3	1450	19,0	2085	direct	175,0	168,0	80

Non-clog impeller allows large diameter of foreign matter with respect to discharge bore. This ensures that waste water and sewage are efficiently transferred.



ø Discharge bore mm		100mm		
Pumping Fluid	Temperature	0-40°C		
	Type of Fluid	Municipal sewage		
Pump	Components	Impeller	Non-clog impeller	
		Shaft Seal	Double mechanical seal	
		Bearings	Shielded ball bearings	
	Material	Impeller	Grey iron casting EN-GJL-200	
		Casing	Grey iron casting EN-GJL-200	
		Suction Plate	Grey iron casting EN-GJL-200	
Shaft Seal	Silicon carbide in oil bath			
Motor	Type, Poles	Induction motor, 4 poles, IP68		
	Lubrication	Turbine oil (ISO VG32)		
	Insulation	Insulation class F		
	Motor Protector (built-in)	Circle thermal cut-out		
	Phase / Voltage	3-phase / 400V / 50Hz / d.o.l.		
	Material	Casing	Grey iron casting EN-GJL-150	
		Shaft	Stainless steel EN-X30Cr13	
Cable		Rubber, 10m H07RN-F		
Discharge Connection	Inside thread, JIS10K flange			
Optional Accessories	Guide rail fitting "TOS" (guide support, duck foot bend, lifting chain) / Bend and stand set for free standing types			

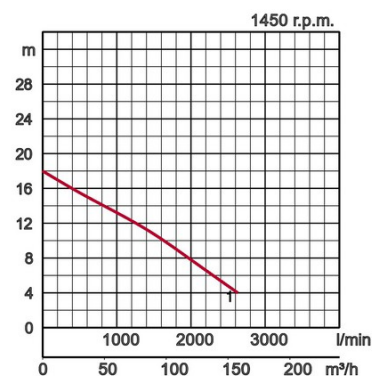

Model	A	A1	A2	A3	B	D	D1	D2	H	W1	W2
100BZ45.5	716	407	204	280	380	421	205	216	925	305	790

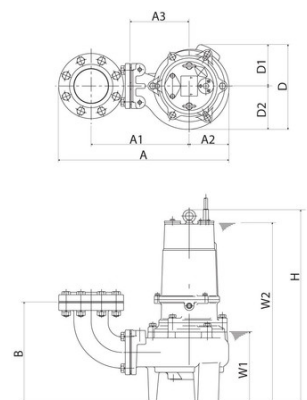

W1: lowest running water level